

### 描述 / Descriptions

TO-263 塑封封装 N 沟道 MOS 场效应管。N-CHANNEL MOSFET in a TO-263 Plastic Package.

### 特征 / Features

阻抗低，开关速度快。

Low On-Resistance, fast switching.

### 用途 / Applications

用于高功率 DC/DC 转换和功率开关。

These devices are well suited for high efficiency switching DC/DC converters and switch mode power supplies.

### 内部等效电路 / Equivalent Circuit

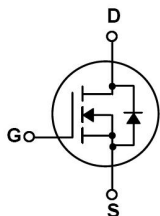

### 引脚排列 / Pinning



PIN1 : G      PIN 2,4 : D      PIN 3 : S

### 放大及印章代码 / $h_{FE}$ Classifications & Marking

见印章说明。 See Marking Instructions

**极限参数 / Absolute Maximum Ratings(Ta=25°C)**

参数 Parameter	符号 Symbol	数值 Rating	单位 Unit
Drain-Source Voltage	$V_{DSS}$	100	V
Drain Current	$I_D(T_c=25^\circ C)$	59	A
Drain Current	$I_D(T_c=100^\circ C)$	42	A
Single Avalanche Current	$I_{DM}$	240	A
Gate-Source Voltage	$V_{GSS}$	$\pm 20$	V
Single Pulsed Avalanche Energy	$I_{AR}$	15	A
Single Avalanche Energy	$E_{AS}$	170	mJ
Power Dissipation	$P_D(T_c=25^\circ C)$	160	W
Storage Temperature Range	$T_J, T_{STG}$	-55 to 150	$^\circ C$
Channel to Ambient Thermal Resistance	$R_{\theta JA}$	40	$^\circ C/W$

**电性能参数 / Electrical Characteristics(Ta=25°C)**

参数 Parameter	符号 Symbol	测试条件 Test Conditions	最小值 Min	典型值 Typ	最大值 Max	单位 Unit
Drain-Source Breakdown Voltage	$BV_{DSS}$	$V_{GS}=0V$ $I_D=250\mu A$	100			V
Zero Gate Voltage Drain Current	$I_{DSS}$	$V_{DS}=100V$ $V_{GS}=0V$			20	$\mu A$
		$V_{DS}=100V$ $V_{GS}=0V$ $T_J=125^\circ C$			250	$\mu A$
Gate-Body Leakage Current Forward	$I_{GSS}$	$V_{GS}=\pm 20V$ $V_{DS}=0V$			$\pm 0.2$	$\mu A$
Gate Threshold Voltage	$V_{GS(th)}$	$V_{DS}=V_{GS}$ $I_D=250\mu A$	2.0		4.0	V
Static Drain-Source On-Resistance	$R_{DS(on)}$	$V_{GS}=10V$ $I_D=35A$		14	18	m $\Omega$
Forward Transconductance	$g_{FS}$	$V_{DS}=50V$ $I_D=35A$	35			S
Drain-Source Diode Forward Voltage	$V_{SD}$	$V_{GS}=0V$ $I_S=35A$ $T_J=25^\circ C$			1.3	V
Input Capacitance	$C_{iss}$	$V_{DS}=25V$ $V_{GS}=0V$ $f=1MHz$		2900		pF
Output Capacitance	$C_{oss}$			290		
Reverse Transfer Capacitance	$C_{rss}$			150		
Turn-On Delay Time	$t_{d(on)}$	$V_{DD}=50V$ $I_D=35A$ $R_G=6.8\Omega$		17		ns
Turn-On Rise Time	$t_r$			77		
Turn-Off Delay Time	$t_{d(off)}$			41		
Turn-Off Fall Time	$t_f$			56		

电参数曲线图 / Electrical Characteristic Curve

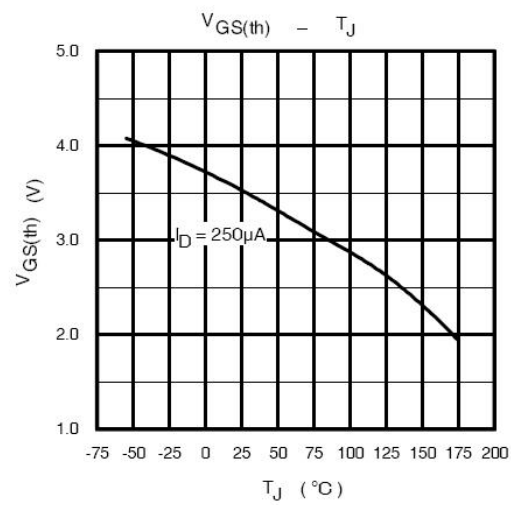
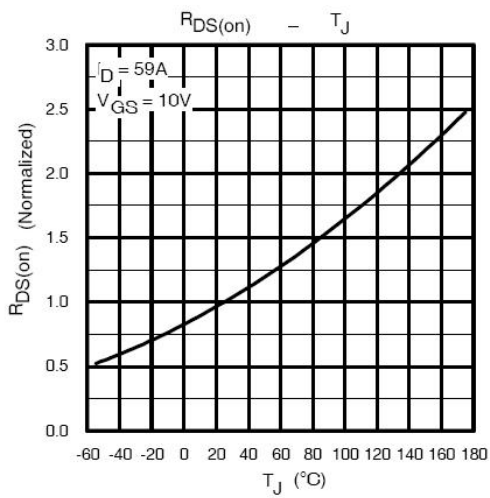
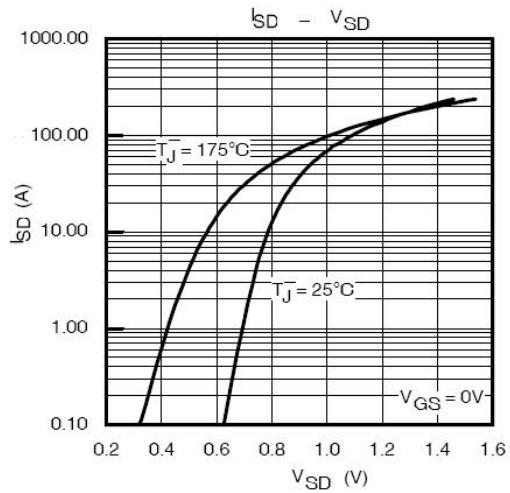
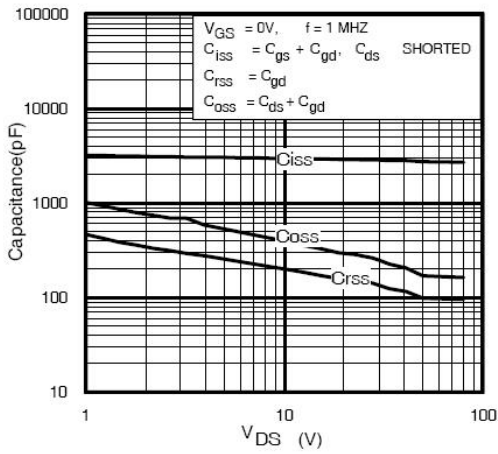
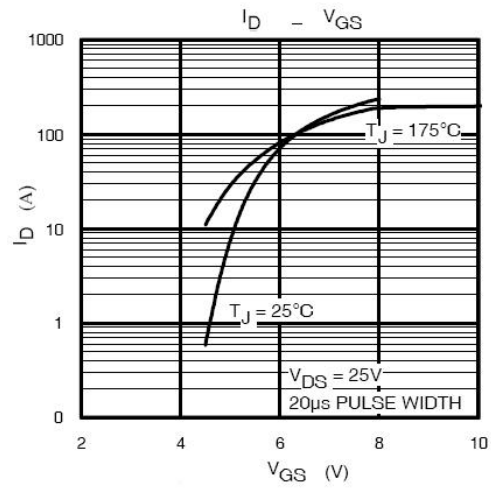
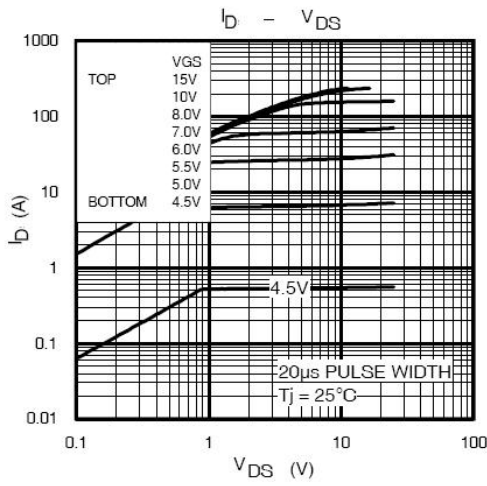

外形尺寸图 / Package Dimensions

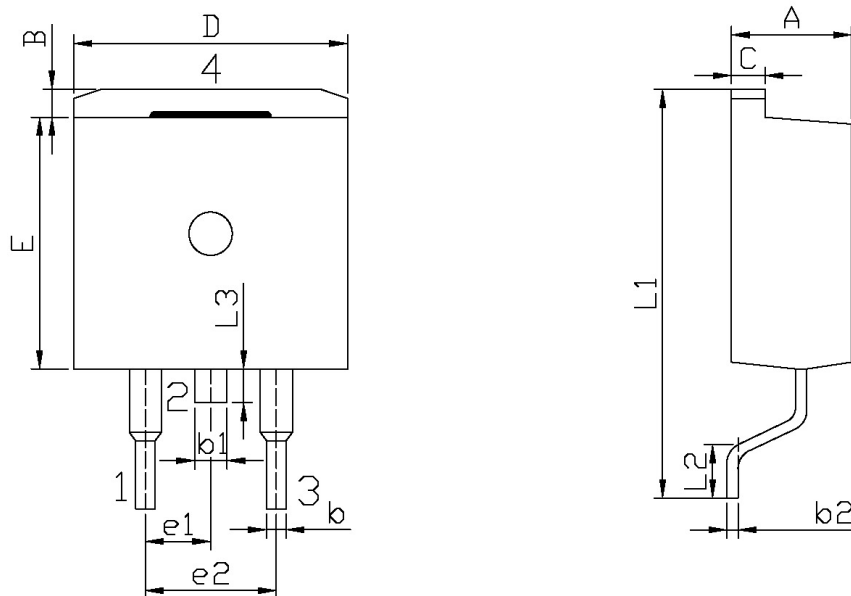

单位: mm

Symbol	Dimensions In Millimeters		Symbol	Dimensions In Millimeters	
	Min	Max		Min	Max
A	4.30	4.70	E	9.00	9.40
B	1.00	1.40	e1	2.34	2.74
b	0.70	0.90	e2	4.88	5.28
b1	1.15	1.35	L1	15.00	16.00
b2	0.40	0.60	L2	2.24	2.84
C	1.20	1.40	L3	1.20	1.60
D	9.80	10.20			

T0-263

印章说明 / Marking Instructions

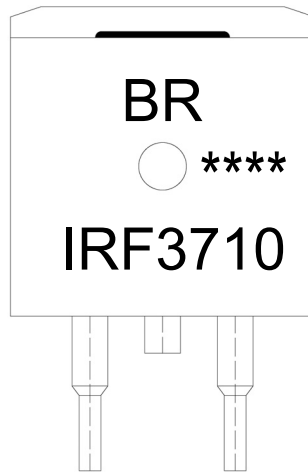

说明：

BR： 为公司代码

IRF3710： 为产品型号

\*\*\*\*： 为生产批号代码，随生产批号变化。

Note:

BR: Company Code

IRF3710: Product Type.

\*\*\*\*: Lot No. Code, code change with Lot No.

**回流焊温度曲线图(无铅) / Temperature Profile for IR Reflow Soldering(Pb-Free)**



说明：

- 1、预热温度 25~150°C，时间 60~90sec;
- 2、峰值温度 245±5°C，时间持续为 5±0.5sec;
- 3、焊接制程冷却速度为 2~10°C/sec.

Note:

- 1.Preheating:25~150°C, Time:60~90sec.
- 2.Peak Temp.:245±5°C, Duration:5±0.5sec.
3. Cooling Speed: 2~10°C/sec.

**耐焊接热试验条件 / Resistance to Soldering Heat Test Conditions**

温度：260±5°C      时间：10±1 sec.      Temp.:260±5°C      Time:10±1 sec

**包装规格 / Packaging SPEC.**

卷盘包装 / REEL

Package Type 封装形式	Units 包装数量					Dimension 包装尺寸 (unit: mm <sup>3</sup> )		
	Units/Reel 只/卷盘	Reels/Inner Box 卷盘/盒	Units/Inner Box 只/盒	Inner Boxes/Outer Box 盒/箱	Units/Outer Box 只/箱	Reel	Inner Box 盒	Outer Box 箱
TO-263	800	1	800	5	4,000	13" x24	360×360×50	385×257×392

套管包装 / TUBE

Package Type 封装形式	Units 包装数量					Dimension 包装尺寸 (unit: mm <sup>3</sup> )		
	Units/Tube 只/套管	Tubes/Inner Box 套管/盒	Units/Inner Box 只/盒	Inner Boxes/Outer Box 盒/箱	Units/Outer Box 只/箱	Tube 套管	Inner Box 盒	Outer Box 箱
TO-263	50	20	1,000	5	5,000	532×33×7.0	555×164×50	575×290×180

**使用说明 / Notices**